

# T6 RANGE

T6.145 | T6.155 | T6.160

T6.165 | T6.175 | T6.180



**MACHINE OF  
THE YEAR 2018**



# Engineered by design to meet your needs.

---

New Holland knows that no two farms are alike, so they have developed the T6 range of fully customisable tractors that you, the owner, can specify to suit your individual needs. If you've ever dreamed of designing your own tractor, those dreams can become reality with the T6 range.







### T6. Strong agricultural design.

Every feature on the T6 range is the fruit of extensive global customer consultation. You asked for more power. It's here. You asked for the ability to work with larger loads. It's here. You wanted business class comfort. Step up and take a look. You need a tractor with compact dimensions suitable for narrow roads and tight in-field turns? Job done. You demanded multitasking flexibility. The T6 delivers. Plus you wanted a good looking tractor with head turning styling. Just take a look.



Model	Number of cylinders	Rated Power hp	Max Power hp	Wheelbase mm	Weight kg
T6.145	4	116	145	2642	5430
T6.155	4	125	155	2642	5430
T6.160	6	135	164	2642	5610
T6.165	4	135	169	2642	5490
T6.175	4	145	175	2642	5490
T6.180	6	150	175	2642	5610

### T6 range: the choice is yours

The six model T6 range is New Holland's definition of farming flexibility. You can choose between four 4 cylinder models, with engine powers spanning 145 – 175hp, or two 6 cylinder models including the range topping T6.180 with a maximum EPM horsepower of 175hp. Select either an Electro Command™ four-speed semi-powershift, available on the T6.145, T6.155, T6.160 and T6.180, or the new eight-speed semi-powershift Dynamic Command™, available on T6.145 - T6.175 4 cylinder models and is now available on the new T6.160 and T6.180 6 cylinder models. New Holland's renowned Auto Command™ continuously variable transmission, is available on the T6.145 - T6.175 4 cylinders models and is now available on the new T6.160 and T6.180 6 cylinder models, designed with two points of mechanical efficiency, it offers the ultimate in ease of operation. With power-to-weight ratios of 31.2kg/hp the T6 is ready and waiting to tackle a full range of farming applications.

# New T6. On top. Around the clock.

The T6 has been designed for today's modern mixed arable farmers and intensive livestock operations and is packed full of features to satisfy even the most demanding users.

**Luxurious comfort.** The industry-leading seat offering includes the Dynamic Comfort range with an ergonomic swivelling backrest and the Auto Comfort™ seat with active heating and ventilation for day-long comfort.

**Outstanding efficiency.** T6 Dynamic Command, 4 cylinder models are the most efficient in their segment, with 9% lower fuel consumption\*.

**Ultimate precision.** A range of guidance solutions are available to meet your needs, including the ultimate in guidance accuracy, the IntelliSteer® fully integrated autoguidance option. Delivering 1.5cm of year-on-year and pass-on-pass accuracy. IntelliTurn™ automated end of row turning functionality can now be combined to automatically trigger HTS II (Headland Turn Sequencing) functionality at a set distance from the headland.

**Unmatched versatility.** The renowned Auto Command™ continuously variable transmission offers precision speed control and ideally positioned points of mechanical efficiency for both field and road applications. The new Dynamic Command™ eight-speed semi-powershift transmission delivers improved productivity and efficiency.

**Increased productivity.** Equip your T6 with up to 16 LED work lights to turn day into night for 24-hour productivity.

**Exceptional safety.** The Intelligent Trailer Brake technology which controls the pneumatic trailer brakes as the tractor decelerates makes for even safer transport work.

**Modern design.** The T6's striking New Holland design will turn heads. Distinctive cat eye lights, signature light and aggressive fish gill vents in the bonnet add up to one good looking tractor.

\* Calculated using independent DLG PowerMix draft cycle average test and 9% lower fuel consumption based on 4 cylinder published DLG test. Data sourced from independent external sources: DLG test reports <http://www.dlg.org/tractors.html> and UK Profi International The Farm Machinery Magazine.

## Improved visibility

Standard on SideWinder™ II model the new low-mounted wiper design has a 175-degree\* sweep that increases the swept area by 60% when compared to the high mounted wiper. To maintain visibility during challenging road conditions there is a 130-degree wiper sweep mode which increases the speed and wiper frequency providing the operator with better vision. In addition, improvements have been made to the wiper stalk functionality and a new self-cancelling indicator stalk has been introduced.

\* excludes Electro Command™ models



Stage V ECOBlue™ HI-eSCR 2 engine,  
up to 175hp maximum horsepower

Modern aggressive styling package

New Holland trademark Cat Eye lights  
with integrated LED signature lights

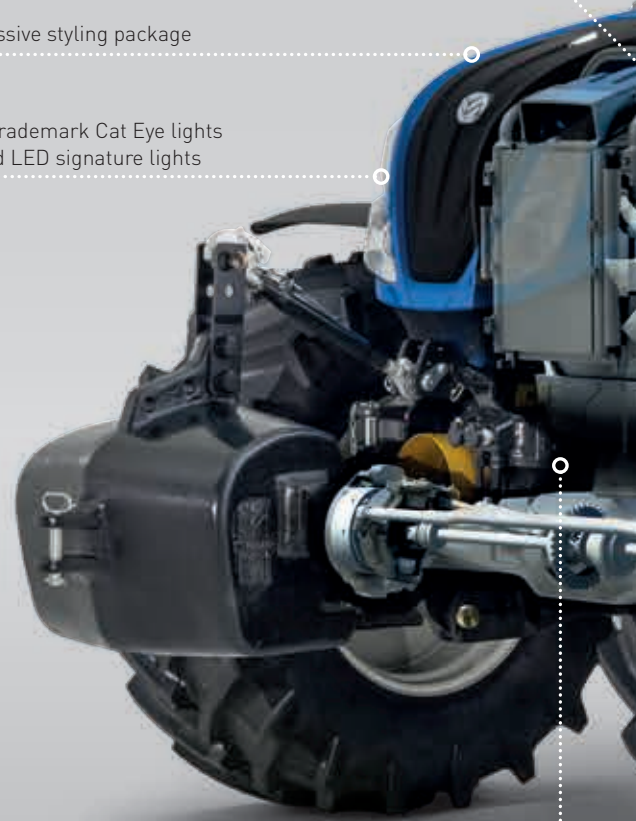

Terraglide™  
front suspension



**MACHINE OF  
THE YEAR 2018**



4 cylinder test  
NEW HOLLAND  
T6.175 DYNAMIC COMMAND  
PowerMix  
RESULT 257g/kWh  
DLG Test Report 6799



6 cylinder test  
NEW HOLLAND  
T6.180 DYNAMIC COMMAND  
PowerMix  
RESULT 266g/kWh  
DLG Test Report 7004





ISOBUS Class III IntelliBale functionality

Hi-visibility roof panel

Factory installed IntelliSteer® guidance system

IntelliTurn™ end-of-row-turn system is now compatible with HTS II (Headland Turn Sequencing) function

IntelliField™ boundary, map & guidance line data inter-vehicle sharing

Up to 16 LED working lights

Horizon™ cab with low noise levels of a mere 69dB(A)

Camera 'ready' option

Advanced seat options

Optional Comfort Ride™ cab suspension

New Holland Intelligent Trailer Brake feature

Headland Turn Sequencing II system

Factory installed wide loader brackets

Proven Auto Command™ continuously variable transmission, the new Dynamic Command™ eight-speed semi-powershift transmission or the renowned Electro Command™ four-speed semi-powershift transmission

## Blue Power. Exclusive Edition.

---

The Blue Power range was developed for those agribusinesses which are looking for the ultimate in premium agriculture. Here performance and comfort are of supreme importance. Add to these attributes exclusive styling and you've discovered the most luxurious tractor range ever. Ultimate comfort, cutting edge technology and eye catching design. If you want your tractor to stand out in the field not only for its performance, but also for its looks, then you've found your answer. Available on both Auto Command™ continuously variable and Dynamic Command™ eight-speed semi-powershift transmissions, the Blue Power range is tractor luxury personified.

*Blue* POWER







- Distinctive metallic midnight blue paint
- Chrome coloured grille
- Silver wheel rims
- Eye catching 3D New Holland and leaf
- Blue Power seat and branded thick pile carpet
- Silver light surround on cab work lights
- An extensive list of standard equipment

**Blue Power. Exclusive edition, exclusive emotion.**

## Horizon™ cab. More space, better visibility.

Want all round visibility? Then New Holland's industry leading Horizon™ cab is the solution. In the yard, in the field or on the road, you have an uninterrupted, productivity enhancing view. Always. The single piece front screen offers a perfect view no matter what the weather or your field throws at you. The sun-visor protects you from the harshest rays. Working with front loaders? Select the high visibility, fully openable transparent roof hatch, which affords a perfect view at maximum extension from the comfort of your seat. Never lose a grain or suffer a crick in your neck ever again. Whisper quiet comfort is courtesy of a mere 69dB(A) cab noise level.

AT 69dB(A), T6 CABS ARE SUPER QUIET







### Control centre

The air conditioning controls, lighting panel, additional storage slots and the radio have all been grouped in an ergonomic cluster.



### An armrest to suit you

Auto Command™ and Dynamic Command™ tractors are equipped with New Holland's multi award-winning SideWinder™ II armrest as standard. But you can also select the SideWinder™ II armrest with mechanical remotes, the standard classic armrest or the upgraded, deluxe armrest with the multifunction handle for even easier operation.



### Good All Round Vision

The standard enlarged wing mirrors feature an adjustable top section for the best possible view of the road during high-speed transport. The adjustable lower section has been designed to effectively counteract blind spots. Additional options included heated wing mirrors and electronically adjustable.



### Farming luxury

The full leather steering wheel and deep pile branded carpet are available as an option. You can select other luxury options such as leather seat, rear sunshade, tinted rear windscreen (standard on SideWinder II models) and heated front and rear windscreen.



# A dynamic solution for Dynamic Command™ models.

---

T6 Dynamic Command™ models can be fitted with two distinct versions of the multi-award winning SideWinder™ II armrest. If you choose to specify your tractor with electronic remote valves, then you will benefit from the many years of development which have gone into the SideWinder II armrest as fitted to T6 Auto Command™ models.

However, if you opt for the mechanical remote option, then your T6 Dynamic Command™ will be equipped with a specifically designed SideWinder™ II armrest, which takes all of the ergonomic excellence and ease of control associated with the SideWinder, with the addition of modern mechanical hydraulic controls.

## Repositioned tractor controls

The integrated tractor control panel has been repositioned, to the front of the armrest, which enables both unfettered access to the mechanical remote valves, whilst simultaneously offering clear sight of the panel under normal operation.







### At a glance gear information

A dedicated screen displaying transmission gearing information has been positioned to the front of the armrest, so that it is easy to see at all times.



### Advanced joystick

The advanced joystick makes for the perfect option when conducting intensive loader work. Whether you are feeding cattle or moving bales, the ability to control electronic remote valves, shuttle between forward / reverse and change gear on Dynamic Command™ and Auto Command™ models through the ergonomically integrated buttons without having to remove your hand from the loader controls is a surefire productivity booster.



### Ideally positioned mechanical remote controls

Up to four mechanical remote controls can be specified and are located to the right hand side of the joystick. Simply reach out your arm and they fall naturally to hand. The smooth and positive operation in all functions, extend-retract-float, extend the premium quality feel to the cab.



### Shuttle responsiveness

The shuttle responsiveness setting can be regulated via a dedicated button on the integrated control panel. Select soft for general field work, standard for daily tasks and the super aggressive position for near instantaneous direction changes during loader work.

# SideWinder™ II: the ultimate ergonomic farming experience.

The T6 Auto Command tractors offer sophisticated features that are easy and intuitive to access. How? Well, we listened to customers and developed the SideWinder™ II armrest to make everything simpler. All key controls are accessed from the armrest. Throttle, transmission and hydraulics. Everything you need to control is intuitively selected. Furthermore, you're benefiting from SideWinder II know-how perfected on T7, T8 and T9 tractor ranges! It does not take long to master a T6 tractor.



The button on the rear of the CommandGrip™ gives access to further functions.



The soft-touch buttons feature backlight technology to make selecting controls in the dark even easier.



## Electronic SideWinder™ II adjustment

You can freely move the armrest to the position that suits you.

Fingertip control for up to two remote valves, which can both be configured with remote valve management.

Headland turn sequencing II (HTS II). Press to record, store and activate automated headland turn.

Optional IntelliSteer® auto-guidance, automated steering engagement.

Rear linkage raise/lower. Front linkage raise/lower (together with CommandGrip™ rear button).

Forward reverse shuttle switch.

ISOBUS configurable buttons.

Multifunction joystick. The joystick can be set to operate the front linkage or remote valves.

Personalised positioning of the hydraulic joystick and rear linkage mouse available as a factory-fit option.

Rear linkage mouse. Lift heavy mounted implements with absolute precision.

Droop control. Select a lower limit for the engine for PTO tasks, or an upper threshold for the maximum engine speed.

Electronic remotes. Easy to reach paddles provide fingertip hydraulic operation. Flow and timing can be simply adjusted through the IntelliView™ touchscreen.

Ergonomically positioned hand throttle.

Full access to advanced hydraulic and rear linkage controls under the padded armrest.

Electronic SideWinder™ II armrest position adjustment.

Engage and disengage the front and rear PTO instantly.





### New instant access hub

This customisable touchscreen feature allows you to change, set and recall key operating parameters at your fingertips in a convenient and quick manner.

26.4cm wide IntelliView™ touchscreen monitor.

Select paddle or joystick control for remote valves 3 and 4.

Easy access to advanced features. Push the symbol. Activate the feature. The Integrated Control Panel, ICP, makes it simple to access advanced operating features.

Engage and disengage the front suspension, or select one of three levels of damping.

Throttle up to your desired engine speed, select Engine Speed Management, and the speed is fixed.

Engage Terralock and it will automatically manage four-wheel drive and differential lock selection.

Auto PTO will disengage and reengage both the front and rear PTOs during a headland turn.

Press the Headland turn sequencing button to record and replay the functions you use most frequently.

Front and rear linkage raise/lower function.

Three point hitch levelling and top link extension at the touch of a button or can be assigned to any remote valve with remote valve management.

Intentional PTO switch, which must be selected to keep the PTO engaged when leaving the operators seat.



# The Ultimate in farming comfort.

New Holland brings to you the best-in class seat offering, with four different models providing you with a wide and comprehensive choice. All seats benefit from improved cushioning. These firmer, more durable seat cushions provide outstanding comfort whatever the terrain. A standard, full-sized upholstered instructor seat folds down to provide a work surface when not in use.



### Dynamic Comfort™ seat

The Dynamic Comfort Seat boasts an enhanced low frequency suspension mechanism. The stitched cushions, finished in a stylish mixture of leather and cloth, also feature two stage heating.

### Comfort seat

The standard Comfort seat uses a low frequency suspension unit. Cushions are finished in a durable dark blue cloth. All seat controls are easily identified ensuring seat adjustments are quick and easy.

### Auto Comfort™ seat

The ventilated Auto Comfort™ seat, only available on Auto Command™ models, offers a premier seating experience. With automatic weight setting, low frequency suspension, heating and even ventilation system that cools and removes moisture, this is perfect for operators who spend extended hours in the tractor. Seat covering is in blue and grey leather



Both the Dynamic Comfort and Comfort seats benefit from the innovative swivelling backrest, designed to provide upper back support and significantly increases comfort when the seat is turned to monitor rear mounted implements.

	Standard seat	Comfort seat	Dynamic Comfort™ seat	Blue Power Dynamic Comfort™ seat	Auto Comfort™ seat	Blue Power Auto Comfort™ seat
Material	Cloth	Cloth	Cloth/Leather	Cloth/Leather	Leather	Cloth/Leather
Suspension type	Low frequency	Low frequency	Low frequency with dynamic damping	Low frequency with dynamic damping	Low frequency with dynamic damping	Low frequency with dynamic damping
Damping system	Adjustable	Adjustable	Automatic	Automatic	Automatic	Automatic
Weight adjustment	Automatic	Automatic	Automatic	Automatic	Automatic	Automatic
Lumbar support	Manual	Manual	Pneumatic	Pneumatic	Pneumatic	Pneumatic
Climate System	-	-	2 stage heater	2 stage heater	Heating and active ventilation	Heating and active ventilation
Backrest extension	Vertically adjusted	Swivelling	Swivelling	Swivelling	Swivelling	Swivelling
Passenger seat	Cloth	Cloth	Leather	Leather	Leather	Leather



# Bright lights for dark nights.

Lighting up the way for improved night time productivity and total safety is a New Holland key priority, accomplished by bringing into the farming world the latest automotive sector innovations, such as LED lights. The lighting offering features up to 16 LED lights. Brighter and less power-consuming than their standard equivalent, these lights offer a broad spread of white light, turning night into day. Up to 6 lights can be fitted in the front and rear of the roof, while high level headlamps light up the distance and pave the way for non stop operation.



## Fully adjustable lights

The optional 360° package includes an adjustable light at each corner of the cab. The rear lights are independently switched to reduce glare if working alongside a harvester.



LED lights are efficiency itself: more light, more durability, less power consumption.



The standard signature lights bring a modern stylish addition to the familiar New Holland hood lights, there's even a New Holland logo within the light unit.

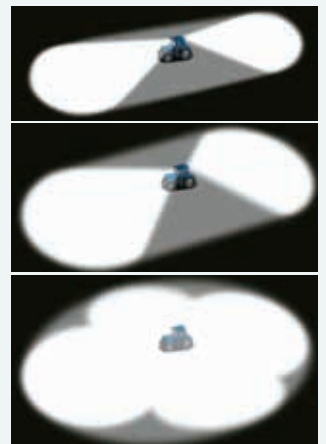

## Choose a lighting package to suit you

There are three cab lighting packages available, consisting of eight, twelve and sixteen LED cab lights in various configurations, to suit your individual requirements.

# Three levels of factory-fitted accuracy.



When ordering your T6, you can choose between three guidance packages. This means that your T6 will arrive direct from the factory with the exact accuracy level you require. Choose your accuracy level right down to the most precise 1.5cm option. A must for high value vegetable or bulb farming.

\* Using RTK correction signal

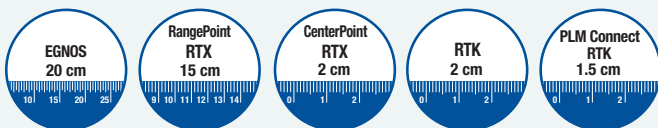

## Levels of accuracy and repeatability

New Holland offer multiple levels of accuracy. This enables you to select the right IntelliSteer® system to match your needs and budget. When using RTK correction with IntelliSteer you can enjoy guaranteed year on year repeatability.



### Advanced IntelliRate™ Control System

The T6 can be specified with the optional IntelliRate™ Control system. It is operated from the comfort of the cab and uses the IntelliView™ monitor to fine tune inputs and manage section and rate control of sprayers and seeding equipment. This prevents overlaps, controls dosing and seed rates depending on yield data and eliminates gaps; this will optimise inputs to maximise outputs.



### IntelliTurn™ intelligent end of row turn system and data sharing IntelliField™ system

The IntelliTurn™, intelligent end of row turning system, enables fully automated end of row turning for tractors equipped with IntelliSteer® autoguidance. The system automatically plots the most efficient end of row turn, to minimise 'out of work' time, as well as ensuring the implement re-enters the work area on the desired path. This can now be combined with HTS II (Headland Turn Sequencing), causing it to trigger at a preset distance from the headland. The new IntelliField™ technology allows you to share boundary, map & guidance line data between tractors operating in the same field to maximize fleet efficiency.



### Two way communication

The T6 range is fitted with ISOBUS III technology. This means the tractor and implement can communicate with each other, relaying information back and forth. When connected to a Roll-Belt baler the IntelliBale™ technology will bring the tractor to a halt as soon the pre-set bale diameter has been reached, net wrap application begins automatically and then the tailgate is raised.



### Telematics: manage your machine from the comfort of your office

MyPLM®Connect enables you to connect to your T6 from the comfort of your office through the utilisation of the mobile network. You can stay in touch with your machines at all times, and you can even send and receive real-time information that saves time and enhances productivity. The entry-level MyPLM®Connect Essential package offers the most frequently used features or upgrade to the MyPLM®Connect Professional package for full machine monitoring and control. In short, MyPLM®Connect will help you to reduce your fuel bills and improve fleet management and security in one simple package.



# The power and efficiency you've come to expect from New Holland.

Your T6 tractor is powered by an ECOBlue™ HI-eSCR 2 (High Efficiency Selective Catalytic Reduction) Nef engine, which has been developed by New Holland's sister company FPT Industrial. These engines, which comply with the even more stringent Stage V emissions norms, offer you four key benefits:

**Performance:** more power, torque, torque back-up and engine power management whilst maintaining outstanding transient response.

**Efficient operation:** the fluid consumption (diesel plus AdBlue) will be the same or better than a Tier 4B T6. You will also benefit from reduced life-long operating costs.

**Simplicity:** the simpler engine installation ensures a higher power potential and the reduced cooling system delivers more efficient operation.

**Consistency:** there will be no change in vehicle operation.



*Sustainable Efficient Technology*

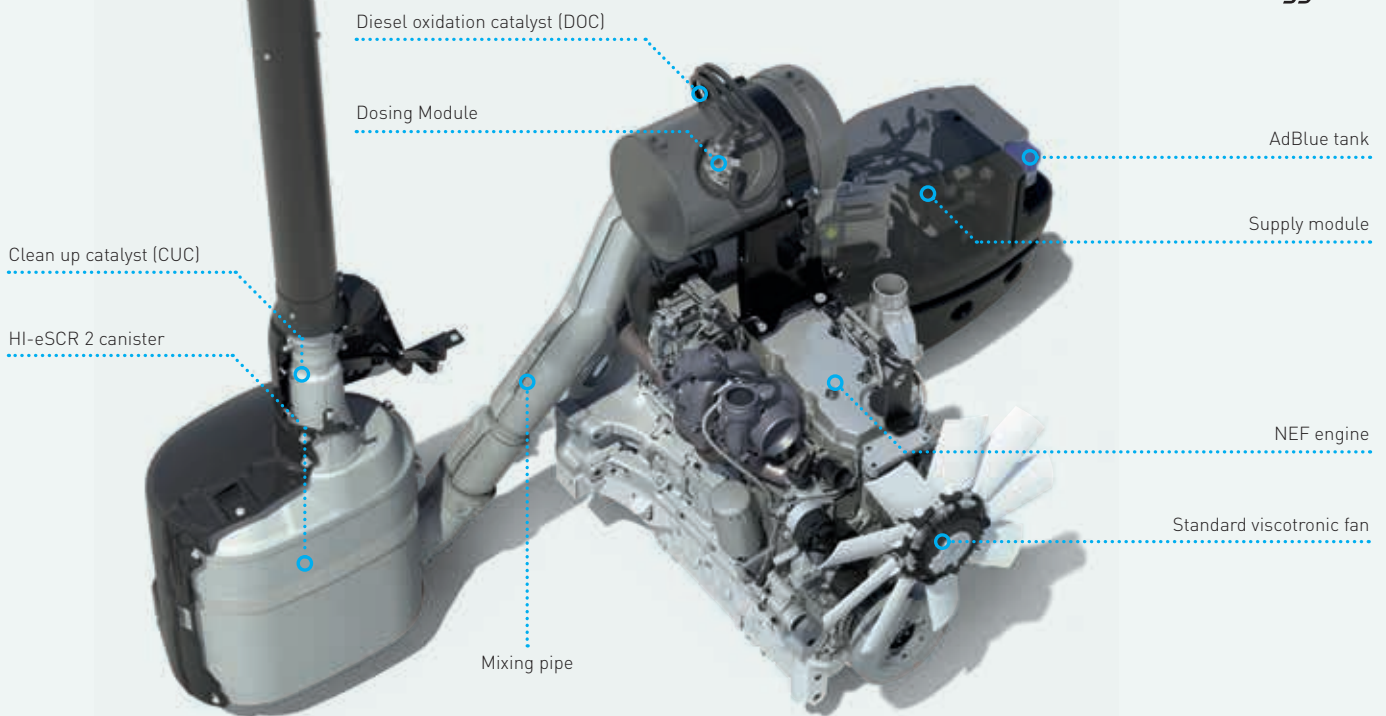

**ECOBBlue HI-eSCR2**

## ECOBBlue™ HI-eSCR 2 explained

The entire T6 range complies with Stage V emissions standards, which mandate a further 40% reduction of Particulate Matter content compared to previous Tier 4B / Stage 4 regulation. This is

achieved thanks to the new HI-eSCR 2 technology developed by FPT Industrial. This innovative after treatment system is a maintenance-free, patented solution that minimises operating costs.



## Powered by FPT Industrial

New Holland is not going it alone when it comes to Stage V technology. They can draw on the experience of their in-house engine development group: FPT Industrial.

**Pioneers:** Fiat invented Common Rail technology in the 1980s and brought it to the masses in 1997 on the Alfa Romeo 156. They were the very first to introduce it on agricultural machines on the TS-A tractor. Pioneering. Always.

**Cleaner:** For the ninth consecutive year, CNH Industrial has topped the Dow Jones Sustainability World and Europe indexes for the Industrial Engineering sector. Cleaner Everywhere.

**Proven:** FPT Industrial has pioneered SCR technology since 1995 and has already produced over 1 million SCR engines during the last eight years for the agricultural, construction and haulage industries. Reliability. Confirmed.



## Best-in-class efficiency

The T6 models equipped with four cylinder engines coupled with the new Dynamic Command transmission have been independently verified as the most efficient tractors in their segment with 9% lower fuel consumption\*. Meaning you get more work done with less fuel. Result.

\* Calculated using independent DLG PowerMix draft cycle average test and 9% lower fuel consumption based on 4 cylinder published DLG test. Data sourced from independent external sources: DLG test reports <http://www.dlg.org/tractors.html> and UK Profi International The Farm Machinery Magazine.

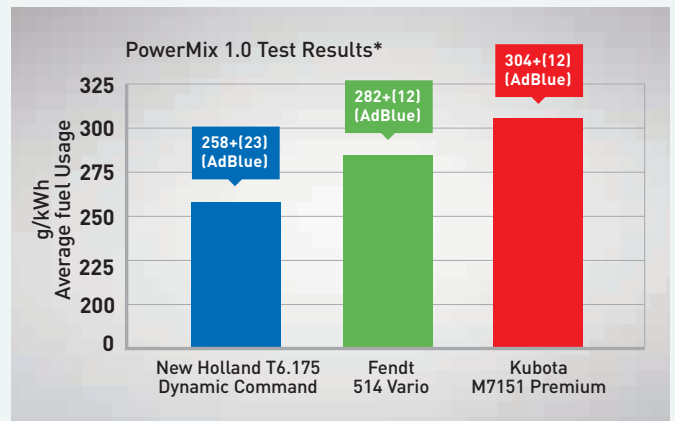

## Engine Power Management explained

With EPM, the engine develops more power and torque according to the load on the transmission, hydraulics and PTO. On a T6.165 tractor, EPM will deliver up to 34 horsepower extra, but only when it is needed, to maintain performance.

- Rated hp: power produced at rated engine speed
- Max hp: power the engine can develop, in the working range
- Rated EPM hp: maximum power the engine can develop using EPM when conditions allow, at rated speed
- Max EPM hp: Maximum power the engine can develop using EPM when conditions allow, in the working range

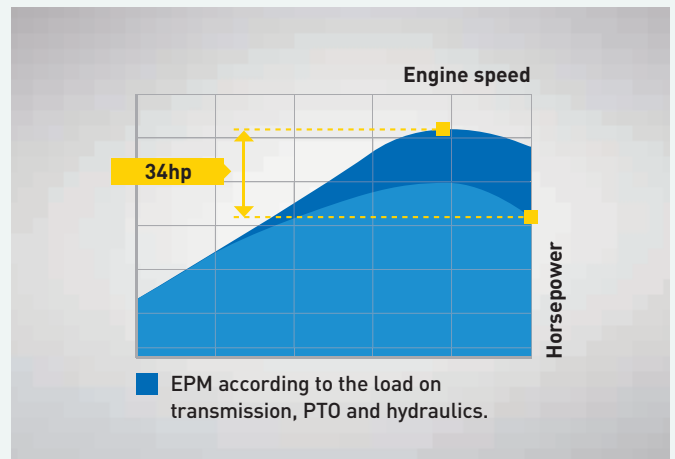

## Transport power management

On Dynamic, Electro and Auto Command™ models, the transport management function comes as standard. This function creates a flat power curve when the tractor comes under load. This is useful in situations such as when going up a hill loaded, as it allows the tractor to maintain its forward speed.

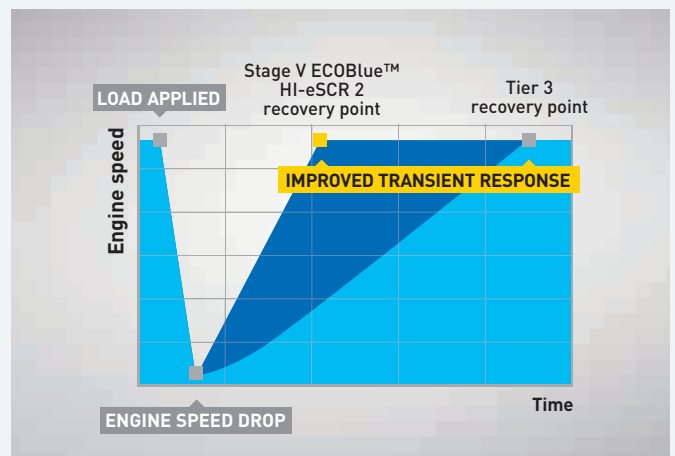

# Select the transmission geared for you.

New Holland knows that every farm has different requirements, and that intelligent innovation also means offering tried and tested solutions to improve efficiency. The semi powershift Electro Command™ transmission offers clutchless gear changes to reduce fatigue, and gear shifting is taken care of for you with the addition of the optional Auto Modes. The latest addition to the Electro Command T6 range is the new 6 cylinder T6.160 model.

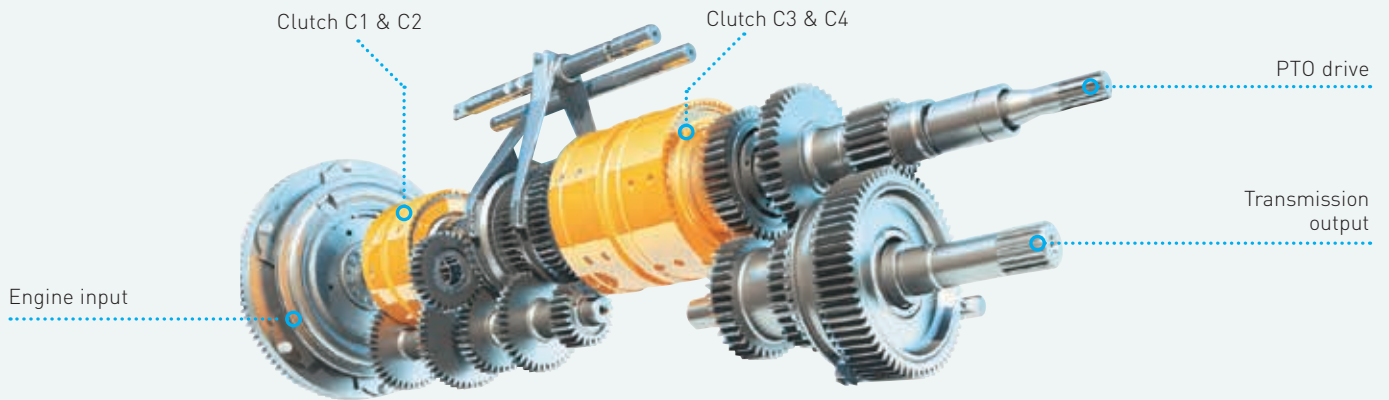



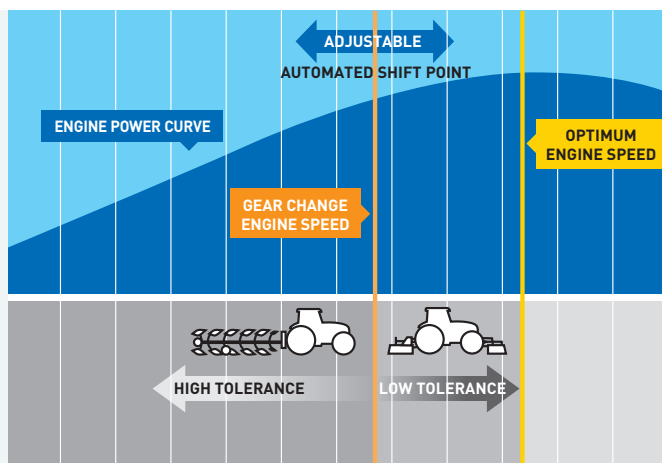

### Work together: automation, comfort and productivity

Auto Transport mode simplifies gear changing and reduces operator input during road work. It can even sense if the tractor is being pushed by a loaded trailer and holds the current gear to provide engine braking.

Auto Field manages both the engine speed and transmission to optimise performance and economy in PTO and draft applications.

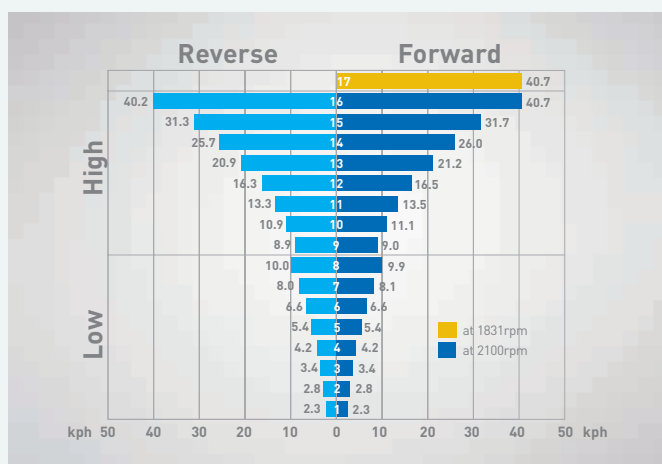

### Electro Command

The Electro Command™ semi-powershift transmission allows you to select eight gear speeds via up and downshift buttons on the control lever. The third button selects the range change. You can see the selected gear at a glance thanks to the large gear display. An additional direct drive 17th gear can be specified that allows either a 50kph transport speed or 40kph at reduced engine speed for reduced fuel consumption. The standard IntelliShift™ technology, improves the quality of the gear shift, automatically selecting the right gear for the job, giving you slick gear changes to improve your comfort and productivity.



### Efficient multi-function handle

You can now specify an ergonomic multifunction handle with Electro Command™ transmissions. This handle falls perfectly to hand and is ideal for operators who frequently change gears as you'll no longer need to stretch. It also hosts front linkage and HTS II activation controls.



### Ergonomic Powershuttle

The column-mounted electro hydraulic Powershuttle can be operated without having to take your hand off the wheel for increased safety during loader work. You can even regulate the aggressiveness setting with an ergonomically positioned switch. Select soft for general field work, standard for daily tasks and the super aggressive position for near instantaneous direction changes during loader work. Want more? You can even change the setting whilst on the move.

### Memory shuttle

The Electro Command features an innovative memory shuttle system that'll save you money and speed up cycle times. First select the ratio you need in forward, shuttle and then shift to your desired reverse ratio. From now on, the tractor will automatically shuttle between your chosen forward and reverse gears. Simple.

# Dynamic operation in every operating situation.

The all-new Dynamic Command™ transmission, fruit of extensive customer consultation and an intensive research, development and testing process, is now available on the new T6.160 and T6.180 6-cylinder models, in addition to the T6.145 - 175 4 cylinder models. Designed to offer even more gears in the most frequently used operating ranges, this will enable you to perfectly match the speed of your T6 to the task in hand. Furthermore, the ability to deliver near instantaneous direction changes makes field, but especially loader work even easier and more efficient.

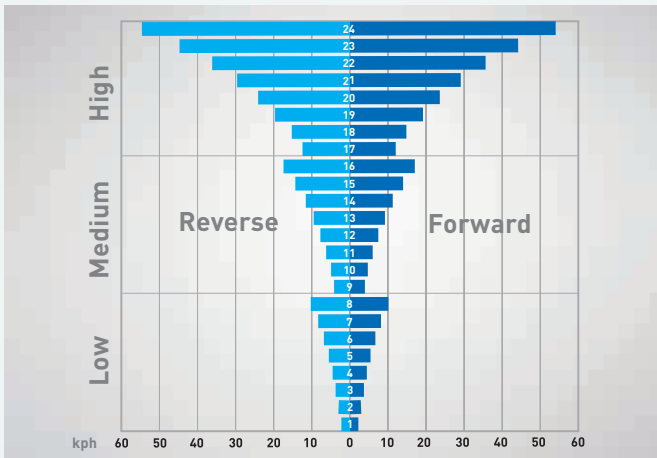
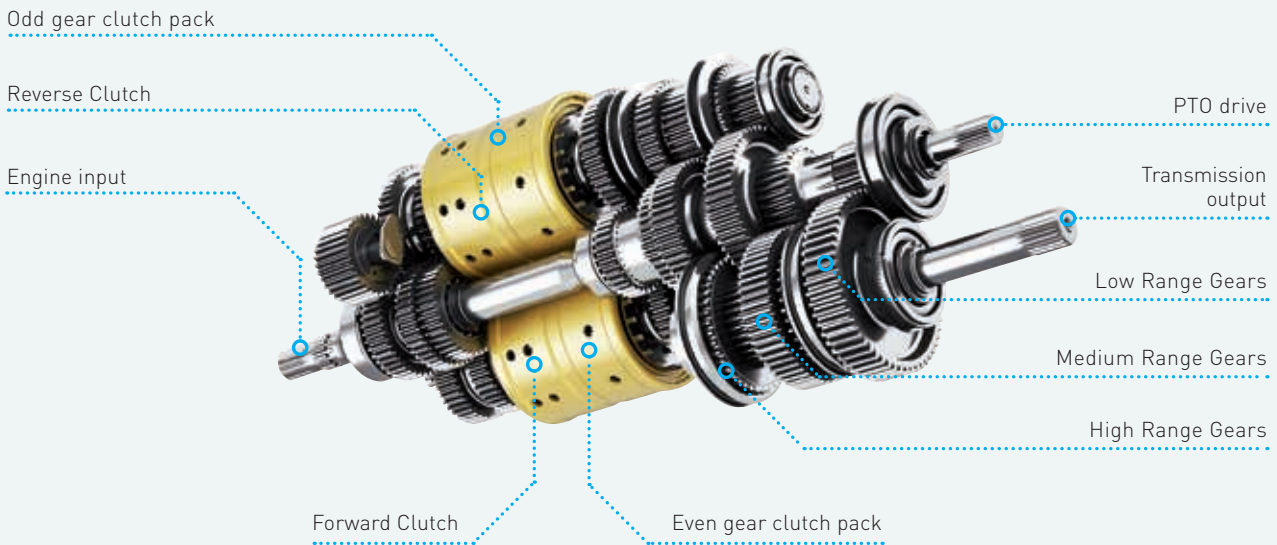

## Eight-step semi-powershift

The 24x24 Dynamic Command™ transmission enables you to shift between eight gears under load, without having to change ranges. Thanks to the wide spread of speeds within the three ranges, which correspond to those most frequently used whilst conducting in field or on road activities, you shouldn't need to change range mid-task, which results in improved infield and on road productivity.

## Fast or slow. You decide.

For transport intensive operation the 40kph ECO or the 50kph ECO offer an efficient way to get between field and back to base, all whilst saving fuel and with lower in-cab noise. At the other end of the scale, a creeper option can be specified so that you can go as slow as you need.





### Responsive powershuttle

The Dynamic Command™ delivers near instantaneous direction changes thanks to advanced powershuttle technology. Conceived with loader-intensive operations in mind, it will speed up all farm yard tasks.



### Clutch free loader work

The advanced Dynamic StartStop feature means that at lower operating speeds, such as those commonly associated with loader work, you can simply depress the brake when coming to a stop, without the need to clutch. Once the brake pedal is released, the tractor will automatically start to move.



### Efficient road transport

When you need that extra turn of speed, such as when accelerating away from a roundabout, the Dynamic Command™ transmission will automatically 'kick down' selecting a lower gear to maximise acceleration performance. Once cruising speed has been achieved, the gearing will automatically revert to the most efficient available.



### GSM II. Intelligent automation.

New Holland Ground Speed Management II, GSM II, is more than just an automated transmission shift system. With CVT-like functionality, it uses a combination of data relating to engine load, forward speed and operator setting, to manage both engine and transmission speeds to optimise performance and economy. Simple to set up and extremely efficient, GSM is well proven and dependable.

# Efficient Auto Command™ transmission offers advanced New Holland features.

Designed and built by New Holland, the Auto Command™ transmission is available on the T6.145 - T6.175 4 cylinders models and is now available on the new T6.160 and the T6.180 6 cylinder models. This CVT transmission benefits from multiple direct drive points with 100% mechanical efficiency which have been precision engineered to ensure that they perfectly match the most frequently used speeds during cultivation and transport. Advanced double clutch control further enhances efficiency. Quite simply, it is the smoothest and most productive CVT around.

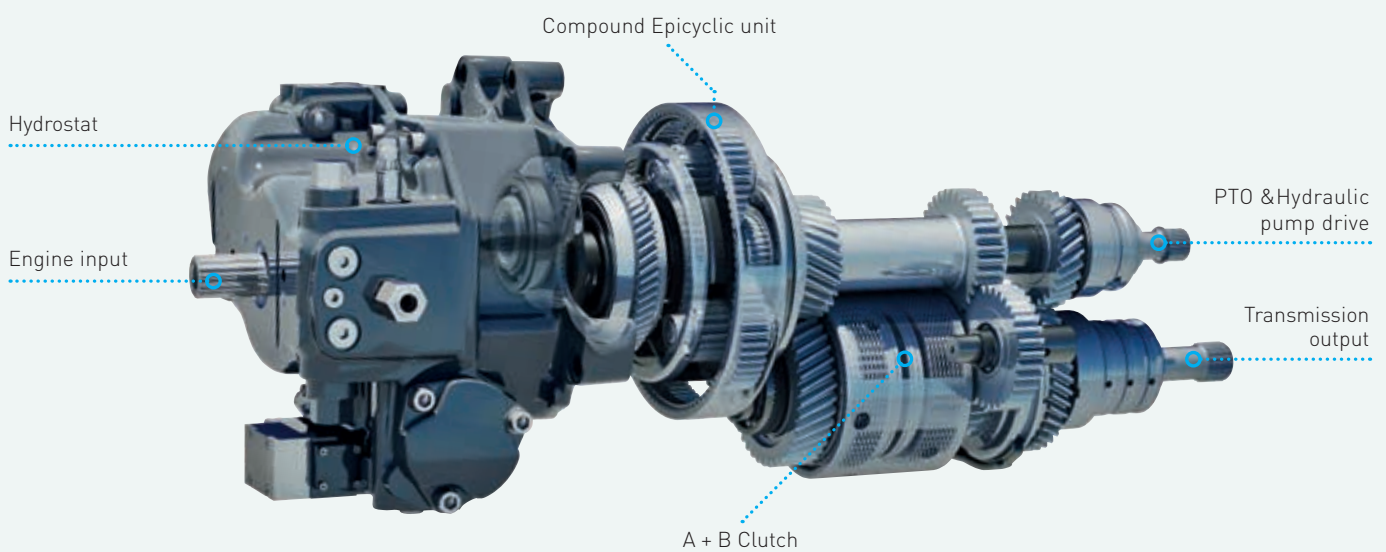

Force based movement enables the operator to change speed and direction. On the ICP there is a switch to alter the response of the speed change. Forward speed can also be controlled using the foot pedal.

Target speed adjustment – set a target speed to match your exact needs. Perfect when moving between fields or when crop yields have altered.

Target speed selection – allows you to change between three target speeds.

4 driving modes to suit your driving style.

**Auto Mode.** Once the desired target speed is achieved, Auto Command will match the engine and transmission to maintain it.

**Cruise Mode.** Cruise Mode allows the operator to achieve a set target speed at the touch of a button, and to maintain the speed for economy and productivity.

**Manual Mode.** Allows the operator to manually set the required engine and forward speed, independently of each other.

**PTO mode.** As soon as the PTO is engaged, Auto Command will operate to achieve a constant engine speed.





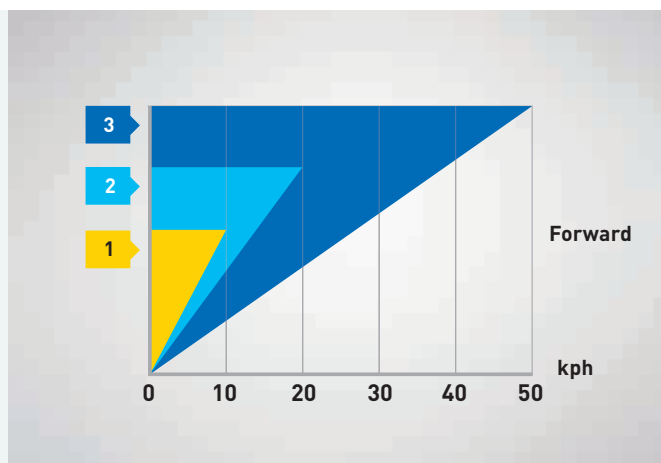

### Three adjustable target speeds for every need

Auto Command technology allows the operator to set a target speed of between 20m/hr right through to 50km/hr and regulate it to the nearest 0.01kph. No steps. No range changes.



### Tailored Transmission settings

The multi-award winning Auto Command™ continuously variable transmission now features a three-stage acceleration and deceleration setting. The 'soft' setting is suitable for gentle direction changes, perfect during high speed transport or when working on slippery surfaces. The standard setting has been designed for normal field activities. The super-fast aggressive setting is ideal when near instantaneous direction changes are required.



### Fast direction changes

Changing direction is simple with Auto Command. The operator can either move the CommandGrip™ handle, use the powershuttle switch on the CommandGrip™ handle or use the steering column mounted shuttle lever.



### Balancing fuel economy and productivity

When working in Auto and Cruise modes, use the droop control dial, situated to the right of the operator, to limit upper engine speed used to achieve the desired forward speed. The result: you reach target speed at much lower engine revs, saving you fuel. In PTO mode, use droop control to regulate the acceptable reduction in PTO speed before forward speed is reduced.

# Great manoeuvrability, improved traction, higher outputs.

---

New Holland's range of axles is engineered to perfectly match your requirements. All T6 tractors can be specified with structurally light but strong front axles to fully exploit a front loader or linkage. An overall maximum gross vehicle weight of 10500kg on all models, when combined with perfect weight distribution and efficient ballasting optimises traction and means you've got even more flexibility when using heavy mounted implements or when ballasting. All models benefit from a 2642mm wheelbase which ensures a 4300mm turning radius for ultimate manoeuvrability. All T6's come with a robust 275mm flanged rear axle as standard. For operations looking for ultimate flexibility.







### CustomSteer™: variable ratio steering

The optional CustomSteer™ function available on Dynamic Command and Auto Command tractors, puts you in control of steering wheel inputs. Through the IntelliView™ monitor or via a dedicated switch, you can control just how many turns of the wheel are required to lock-to-lock functionality. If you want to conduct tight turns, say when turning on the headland or when conducting loader work, you can programme the tractor to deliver lock-to-lock turning with anything as few as one complete steering wheel revolution, instead of the standard four. Saving you time and effort.

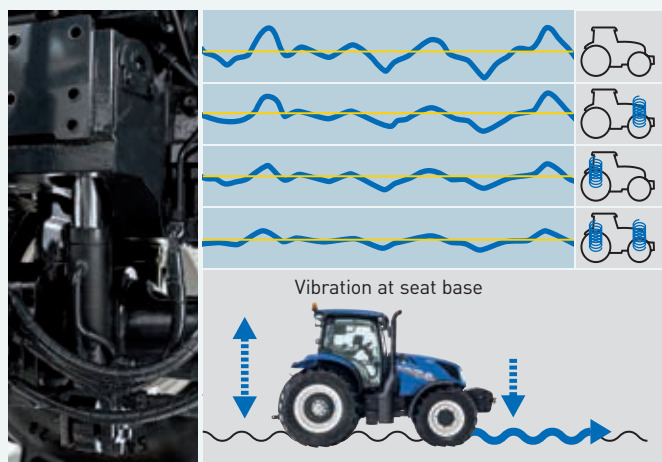

### Terraglide, your comfort and stability partner

For maximum comfort at high transport speeds, choose the Terraglide™ front axle suspension system. How does it work? It cushions the operator from shocks when travelling over uneven surfaces. In the field the advanced suspension system maintains contact between the tyre and the ground to improve traction. It also features anti-dive and anti-squat logic which prevents excessive suspension movement when lifting heavy three point linkage implements. The integrated Comfort Ride™ Cab suspension provides up to a 25% reduction in shock loads reaching the operator. The result? Less fatigue over long working days, as whole body vibrations are significantly reduced.

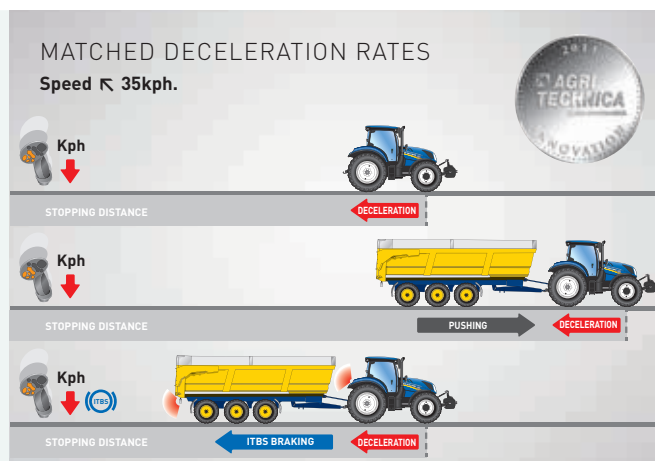

### Intelligent Trailer Brakes

When a tractor and trailer are slowed by just the transmission and engine braking alone the momentum of the trailer will push against the tractor. This pushing force can cause instability, which may increase the potential risk of a jack knife situation, especially on steep gradients or low friction surfaces such as icy roads or grassland. The Intelligent Trailer Braking System senses the reduction in the tractor's speed and calculates the deceleration force using a torque sensor within the transmission. An electronically controlled trailer brake valve then automatically applies the trailer brakes to reduce the trailer's speed at the same rate as the tractor. No modifications are required to the trailed equipment.



### Terralock™ automatic traction management

New Holland's renowned Terralock™ solution is simple to set-up and operate. It automatically manages the engagement of drive to the front axle, locking both the front and rear differentials. Forward speed and steering angle information dictate when the differential locks and, if required, four wheel drive disengages. Why? To guarantee the tightest turning circles and to reduce strain on the driveline.

# Productivity and flexibility guaranteed.

New Holland knows that full integration by design is the best option. That is why the T6 was designed with front loaders and front linkage in mind. The T6 is fully compatible with the wide frame New Holland 600LA & 700LA ranges of front loaders: the perfect productivity combination. Moreover, you'll always have a perfect view of your load at full extension from the comfort of your seat thanks to the optional high visibility, transparent roof hatch. Moreover, you no longer have to choose between front loader or front linkage, with the T6 you can have both.



## Strong, efficient and powerful

The maximum lift capacity on four and six cylinder models is a massive 7864kg. The rear linkage and hydraulics are designed to work with heavy mounted equipment over extended periods. The system also incorporates integral dynamic ride control shock load protection. This will reduce bounce when travelling with a heavy linkage load at transport speeds. Fender mounted controls for the rear linkage, a rear remote and the PTO are available.



## The perfect fit: front linkage and PTO

New Holland's T6 range is designed to incorporate a fully integrated, factory fitted, front linkage and PTO. All linkage and PTO controls can either be accessed from the comfort of the cab, or via the conveniently positioned controls on the linkage itself for greater efficiency when hitching. Purpose developed for T6 tractors, the linkage will lift up to 3200kg. Linkage arms can be folded when not in use, or can be used to carry the mono block front weight pack.





### Long, strong, productive

The wide frame 600LA & 700LA range's vital statistics are rather impressive: maximum lift heights of 4.3 metres and lift capacities of up to 3345kg mean that no task is too big or too small. The numbers speak for themselves. But there's more. The hydraulic pipe work has been integrated into the loader frame to significantly improve forward visibility for precision operation and to prevent potential snagging when operating in the confined sheds.

### FOPS: your safety partner

New Holland offers you the ultimate in loader peace of mind, as the T6 is fully FOPS (falling object protection system) compliant, to guard against injury from falling objects.

Model		685LA	680LA	695LA	690LA	715LA	725LA	735LA	730LA	745LA
Max. lift height	(m)	3.9	3.9	3.9	3.9	4.1	4.1	4.1	4.1	4.3
Max. lift capacity	(kg)	2723	2723	3131	3131	2559	2937	3345	3345	2712
<b>T6.145</b>		✓	✓	✓	✓	✓	✓	✓	✓	✓
<b>T6.155</b>		✓	✓	✓	✓	✓	✓	✓	✓	✓
<b>T6.160</b>		✓	✓	✓	✓	✓	✓	✓	✓	✓
<b>T6.165</b>		✓	✓	✓	✓	✓	✓	✓	✓	✓
<b>T6.175</b>		✓	✓	✓	✓	✓	✓	✓	✓	✓
<b>T6.180</b>		✓	✓	✓	✓	✓	✓	✓	✓	✓

✓ Available



## Hydraulic power and PTO flexibility.

---

Have you ever thought about just how much hydraulic flow you actually need? All Electro Command™ and Dynamic Command™ models are fitted with the traditional open centre hydraulic system as standard. Delivering 86 litres/minute, it is more than sufficient for the majority of farming applications. On Electro Command™ models, an optional 121 litres/minute CCLS pump is available rising to 150 litres/minute on Dynamic Command™ models that will power even the most demanding implements including specialist vegetable harvesters. Auto Command offers 150 litres/minute of flow as standard. If that wasn't enough, New Holland has engineered the CCLS system to operate at peak efficiency. The benefit? Full hydraulic power is always available at the remote valves and linkage, but only as much as is needed. The result? Reduced fuel consumption. Regardless of how hard your Electro Command tractor is working, the steering will always remain light and easy to use, and loader cycle times remain uncompromised thanks to a separate 47 litres/minute service pump or optional 67 litres/minute pump when fitted with Class 4 front axle.







### Remote valves

The T6 range can be specified with up to four electronic or mechanical rear remote valves. Up to three mid mount remote valves to operate the front linkage or a loader are also available, and they are controlled via an ergonomic, fully integrated joystick in the cab.



### Even easier hydraulic connection

The hydraulic valve blocks at the rear of the tractor have been split in two to make it even easier when connecting hydraulic lines. The block on the left controls two sets of remotes and the block on the right controls two sets of remotes. In addition a 5th spool diverter and power beyond are also available. Simple. Intuitive. T6.



### Direct drive for fuel efficiency

All T6 tractors are fitted with a direct drive PTO to minimise power loss between the engine and the implement. The PTO is engaged via a push-pull control, with advanced Soft Start management. This modulates engagement of high inertia attachments to protect the driveline. Safety has been further enhanced with the inclusion of an intentional PTO switch, which must be selected to keep the PTO engaged when leaving the operator's seat. Additional PTO options include Auto PTO which disengages PTO at pre-set rear linkage heights and a 540E/1000/1000E PTO option with an engine speed of a mere 1621 engine rpm to significantly reduce your fuel consumption.



### Electronic draft control

A single raise/lower switch makes it simple to lift and return an implement to work during a headland turn. How? New Holland's ergonomic EDC is positioned just to your right, exactly where you need it, giving you ultimate precision. To fine-tune the system you can use the intuitive controls that are found underneath the armrest, precisely where you would expect them to be. You can even activate the HTS II functionality with your thumb at the touch of the ergonomically located button.

### Headland Turn Sequencing II and IntelliTurn™ system: hassle free repeatability

HTS II is available on models fitted with Electro hydraulic remotes. This intuitive system means you can easily record and store all implement sequences and operations at the headland. These can then be played back at the touch of a button. Now, it gets interesting. It's even easier to modify pre-recorded sequences, so when things change, your HTS sequence does as well! If you want the ultimate in turning simplicity, combine this with IntelliTurn, the automated end of row turning functionality, which triggers HTS II when it reaches a preset distance from the headland. Two great ways to improve repeatability and efficiency as well as to reduce fatigue when working over extended periods.



# 360°: T6 class leading service intervals.

The T6 range has been designed to spend more time working and less time in the yard. All service points are easy to access, and super long 750 hour engine, and 1500hr transmission intervals mean they will spend more time in their natural environment: the field!



## Dealer Installed Accessories

A comprehensive range of approved accessories to optimise machine performance in all conditions can be supplied and fitted by your dealer.



# New Holland Uptime Solutions.



## Control room

Using data from MyPLM®Connect, skilled technicians analyse specific triggers in the cloud to implement solutions as required. If an issue is identified, the system proactively sends an alert to dealers with the corrective action. Then dealers can prepare in-field or remote assistance and in addition New Holland can support the process to find the quickest solution. That's New Holland's commitment to its customers.



## Uptime support

The priority assistance service for New Holland machines. A dedicated team operates around the clock to manage the requests, which can be activated through the MyNew Holland™ app and the Top Service toll free number. New Holland and the Dealer network will do all possible to provide support, checking many options to get our customers back on the move as quickly as possible and the request will be followed up until the machine is fully repaired. The team relies on a Priority Parts process and dedicated service team, to reach a fast resolution. The service is able to solve more than 80% of breakdowns in less than 48 hours, this is our commitment to our customers!



## Uptime parts

New Holland knows how important it is to minimize machine downtime and get back quickly to your farming. New Holland parts logistics is organized in order to ensure error-free and rapid parts distribution. An efficient integrated stock management system allow to our six strategically positioned European Depots excellent performance 24/7.



## Uptime service

Minimum downtime, maximum resale value. Your machine is always in top condition, with professional support and high quality genuine parts you maintain the value of your equipment over time.



## Uptime Warranty

Uptime Warranty is the New Holland Extended Warranty program under the same conditions as the Base Warranty. Maximum control over operating costs, maximum improvement of the uptime, repairs completed by authorized New Holland Dealers using New Holland genuine parts, higher re-sale value of your machine are some of the key benefits. Please ask your Dealer for more details and for a tailored Uptime Warranty offer\*.

\* Refer to Uptime Warranty detailed terms and conditions at your Dealer



## MyNew Holland™ will improve your daily work

MyNew Holland™ will improve your daily work: get access to exclusive information by adding your equipment, find online solutions for your PLM® products, download operator manuals. Whenever you want, wherever you want - and free of charge.

## New Holland Style

Want to make New Holland a part of your everyday life? Browse the comprehensive selection on [www.newhollandstyle.com](http://www.newhollandstyle.com). A whole range of items are available including hard wearing work clothing and a vast selection of scale models, together with so much more. New Holland. As individual as you.

Models	T6.145	T6.155	T6.160	T6.165	T6.175	T6.180
<b>New Holland engine*</b>	<b>Nef</b>	<b>Nef</b>	<b>Nef</b>	<b>Nef</b>	<b>Nef</b>	<b>Nef</b>
No. of cylinders / Aspiration / Valves	4 / T / 4	4 / T / 4	6 / T / 4	4 / T / 4	4 / T / 4	6 / T / 4
Compliant with engine emissions regulations	Stage V	Stage V	Stage V	Stage V	Stage V	Stage V
ECOBBlue™ HI-eSCR 2 system (Selective Catalytic Reduction)	●	●	●	●	●	●
Fuel System - High Pressure Common Rail	●	●	●	●	●	●
Capacity [cm³]	4485	4485	6728	4485	4485	6728
Bore and Stroke [mm]	104x132	104x132	104x132	104x132	104x132	104x132
Approved Biodiesel blend**	B7	B7	B7	B7	B7	B7
Max. EPM horsepower - ISO TR14396 - ECE R120 [kW/hp(CV)]	107/145	114/155	121/164	124/169	129/175	129/175
Max. horsepower - ISO TR14396 - ECE R120 [kW/hp(CV)]	92/125	99/135	107/145	107/145	114/155	116/158
Rated EPM horsepower - ISO TR14396 - ECE R120 [kW/hp(CV)]	96/131	103/140	110/150	114/155	118/160	121/165
Rated horsepower - ISO TR14396 - ECE R120 [kW/hp(CV)]	85/116	92/125	99/135	99/135	107/145	110/150
Rated engine speed [rpm]	2200	2200	2200	2200	2200	2200
Max. EPM torque - ISO TR14395 (Nm @ rpm)	590 @ 1500	640 @ 1500	707 @ 1500	700 @ 1500	700 @ 1500	738 @ 1500
Max. torque - ISO TR14396 (Nm @ rpm)	528 @ 1500	560 @ 1500	611 @ 1500	605 @ 1500	650 @ 1500	650 @ 1500
Torque rise standard / EPM (%)	41 / 42	40 / 43	40 / 46	40 / 42	40 / 37	40 / 40
Engine Speed Management	●	●	●	●	●	●
Exhaust brake	○	○	○	○	○	○
Diesel tank capacity standard tank / wide tank [Litres]	218 / 263	218 / 263	218 / 263	218 / 263	218 / 263	218 / 263
AdBlue tank capacity [Litres]	31	31	31	31	31	31
Service interval [hours]	750	750	750	750	750	750
<b>Electro Command™ 4 step semi powershift transmission</b>	○	○	○	-	-	○
Powershuttle lever with aggressiveness setting switch	●	●	●	-	-	●
Auto transmission functions	●	●	●	-	-	●
IntelliShift™ System	●	●	●	-	-	●
Basic Gear Display	●	●	●	-	-	●
High mount window wiper	●	●	●	-	-	●
<b>Electro Command™ transmission (40kph)</b>	○	○	○	-	-	○
Number of gears / with Creeper [F/R]	16x16 / 32x32	16x16 / 32x32	16x16 / 32x32	-	-	16x16 / 32x32
Minimum speed / Minimum speed with Creeper [kph]	2.27 / 0.19	2.27 / 0.19	2.27 / 0.19	-	-	2.27 / 0.19
<b>Electro Command™ transmission (40kph ECO or 50 kph)</b>	○	○	○	-	-	○
Number of gears [F/R]	17x16	17x16	17x16	-	-	17x16
Minimum speed [kph]	2.27	2.27	2.27	-	-	2.27
Basic Gear Display	●	●	●	-	-	●
<b>Dynamic Command™ 8 step semi powershift transmission</b>	○	○	○	○	○	○
Transport Power Management	●	●	●	●	●	●
Powershuttle lever with aggressiveness setting switch	●	●	●	●	●	●
Auto transmission functions	●	●	●	●	●	●
Ground Speed Management II (GSM II)	○	○	○	○	○	○
Dynamic Start/Stop	○	○	○	○	○	○
Dynamic IntelliShift™ System	●	●	●	●	●	●
Basic Gear Display	●	●	●	●	●	●
Low mount window wiper	●	●	●	●	●	●
<b>Dynamic Command™ transmission (40kph)</b>	○	○	○	○	○	○
Number of gears [F/R]	23x23	23x23	23x23	23x23	23x23	23x23
Minimum speed [kph]	2.22	2.22	2.22	2.22	2.22	2.22
<b>Dynamic Command™ transmission (40 ECO &amp; 50kph ECO)</b>	○	○	○	○	○	○
Number of gears [F/R]	24x24	24x24	24x24	24x24	24x24	24x24
Minimum speed [kph]	2.22	2.22	2.22	2.22	2.22	2.22
Basic Gear Display	●	●	●	●	●	●
<b>Auto Command™ Continuously Variable Transmission</b>	○	○	○	○	○	○
Powershuttle lever with aggressiveness setting switch	●	●	●	●	●	●
Active Stop/Start function	●	●	●	●	●	●
Force base propulsion control	●	●	●	●	●	●
Low mount window wiper	●	●	●	●	●	●
<b>Auto Command™ Continuously Variable Transmission (40kph or 40kph ECO)</b>	○	○	○	○	○	○
Min. speed / Max. speed @ 1550rpm [kph]	0.02 / 40	0.02 / 40	0.02 / 40	0.02 / 40	0.02 / 40	0.02 / 40
<b>Auto Command™ Continuously Variable Transmission (50kph ECO)</b>	○	○	○	○	○	○
Min. speed / Max. speed @ 1700rpm [kph]	0.02 / 50	0.02 / 50	0.02 / 50	0.02 / 50	0.02 / 50	0.02 / 50
<b>Electrical</b>						
12 volt alternator Standard/Optional [Amps]	120/150/200	120/150/200	120/150/200	120/150/200	120/150/200	120/150/200
Standard battery capacity [CCA/Ah]	800/140	800/140	800/140	800/140	800/140	800/140
Optional heavy duty battery capacity [CCA/Ah]	1300/176	1300/176	1300/176	1300/176	1300/176	1300/176
<b>Axles</b>						
Terraglide™ front axle suspension	○	○	○	○	○	○
Steering angle 4WD / Terraglide™ front axle [°]	55 / 55	55 / 55	55 / 55	55 / 55	55 / 55	55 / 55
CustomSteer™ system	○	○	○	○	○	○
Terralock™ functions (Auto Diff / Auto 4WD)	○	○	○	○	○	○
Dynamic Front Fenders	○	○	○	○	○	○
Bar rear axle	○	○	○	○	○	○
Turning radius with 4WD / Terraglide™ suspended front axle [mm]	4600	4600	4600	4600	4600	4600
<b>Hydraulics</b>						
Fixed Displacement	●	●	●	●	●	●
Electro Command main Pump flow / Pump pressure [Lpm / Bar]	86 / 190	86 / 190	86 / 190	86 / 190	86 / 190	86 / 190
Dynamic Command main Pump flow / Pump pressure [Lpm / Bar]	86 / 190	86 / 190	86 / 190	86 / 190	86 / 190	86 / 190
Closed Centre Load Sensing (CCLS)	○	○	○	○	○	○
Electro Command Main Pump flow / Pump pressure [Lpm / Bar]	121 / 210	121 / 210	121 / 210	121 / 210	121 / 210	121 / 210
Dynamic Command Main Pump flow / Pump pressure [Lpm / Bar]	150 / 210	150 / 210	150 / 210	150 / 210	150 / 210	150 / 210
Auto Command Main Pump flow / Pump pressure [Lpm / Bar]	150 / 210	150 / 210	150 / 210	150 / 210	150 / 210	150 / 210
Standard Steering and services pump flow [Lpm / Bar]	47 / 170	47 / 170	47 / 170	47 / 170	47 / 170	47 / 170
Optional Steering and services pump flow*** [Lpm / Bar]	67 / 170	67 / 170	67 / 170	67 / 170	67 / 170	67 / 170
Electronic Draft Control (EDC)	●	●	●	●	●	●
<b>Remote valves</b>						
Max. no. Deluxe rear valves with diverter fitted	5	5	5	5	5	5
Max. no. Electro hydraulic rear valves with diverter fitted	5	5	5	5	5	5
Max. no. mid mount valves	3	3	3	3	3	3
Mid mount Mechanical joystick control****	○	○	○	-	-	○
Mid mount Advanced Joystick control (Forward / Reverse + Gear Change)	○	○	○	○	○	○
<b>Linkage</b>						
Max. lift capacity at ball ends [kg]	7864	7864	7864	7864	7864	7864
Max. lift capacity through the range (610mm behind ball ends) [kg]	5284	5284	5284	5284	5284	5284
Front linkage lift capacity at ball ends (through the range) [kg]	3200	3200	3200	3200	3200	3200
<b>Front Loader Ready</b>	○	○	○	○	○	○
Seat mounted integrated loader joystick	○	○	○	○	○	○
<b>PTO</b>						
Auto Soft Start	●	●	●	●	●	●
Engine speed at:						
540/1000 [rpm]	1969/1893	1969/1893	-	-	-	-
540/540E/1000 [rpm]	1969/1546/1893	1969/1546/1893	1969/1546/1893	1969/1546/1893	1969/1546/1893	1969/1546/1893
540E/1000/1000E [rpm]	-	-	-	-	1592/1893/1621	1592/1893/1621
Auto PTO management	○	○	○	○	○	○
Front PTO (1000rpm)	○	○	○	○	○	○



Models	T6.145	T6.155	T6.160	T6.165	T6.175	T6.180
<b>Brakes</b>						
Hydraulic Trailer Brakes	○	○	○	○	○	○
Optional Pneumatic Tractor Brakes	○	○	○	○	○	○
Auto Command Intelligent trailer brake system	○	○	○	○	○	○
Auto Command electronic park brake	●	●	●	●	●	●
<b>Cab</b>						
Four pillar 360° Horizon™ cab with FOPS - OECD Code 10 Level 1	●	●	●	●	●	●
Horizon cab category level - EN 15695	2	2	2	2	2	2
Low profile roof	○	○	○	○	○	○
High visibility roof hatch	○	○	○	○	○	○
8 LED lighting pack	●	●	●	●	●	●
12 LED lighting pack	○	○	○	○	○	○
16 LED 360 degree lighting pack	○	○	○	○	○	○
Heated front and rear windscreen	○	○	○	○	○	○
Comfort seat with seat belt	●	●	●	●	●	●
Dynamic Comfort™ heated seat with seat belt	○	○	○	○	○	○
Auto Comfort™ Active Climate Control, leather seat with seat belt	○	○	○	○	○	○
Auto Comfort™ Active Climate Control, Blue Power trim with seat belt	○	○	○	○	○	○
Instructors seat with seat belt	○	○	○	○	○	○
Luxury Pack (Leather Steering wheel and carpet)	○	○	○	○	○	○
Tilting and telescopic steering column	●	●	●	●	●	●
Air conditioning	○	○	○	○	○	○
Automatic climate control	○	○	○	○	○	○
MP3 Bluetooth Radio (hands free phone calls)	○	○	○	○	○	○
Telescopic mirrors with wide angle view	○	○	○	○	○	○
Telescopic mirrors with wide angle view, heating and electrically adjustable	○	○	○	○	○	○
Comfort Ride™ cab suspension	○	○	○	○	○	○
Fender mounted external PTO & Linkage controls	○	○	○	○	○	○
Fender mounted external remote valve control	●	●	●	●	●	●
Optimum Horizon cab noise level - 77/311EEC [dB(A)]	○	○	○	69	○	○
Factory Fit Rotating Beacons (1 / 2)	○	○	○	○	○	○
<b>New Holland Precision Land Management (PLM) systems</b>						
<b>Field - Onboard Systems</b>						
Classic armrest	○	○	○	-	-	○
SideWinder™ II armrest	○	○	○	●	●	○
CommandGrip™ handle	○	○	○	○	○	○
Performance Monitor with enhanced key pad and ISO 11786 connector	○	○	○	○	○	○
Auto Command™ IntelliView™ IV colour monitor with ISO 11783 connector	●	●	●	●	●	●
Dynamic Command™ IntelliView™ IV colour monitor with ISO 11783 connector	○	○	○	○	○	○
Dual IntelliView™ IV colour monitor with ISO 11783 connector	○	○	○	○	○	○
Camera Connection	○	○	○	○	○	○
Cab monitor mounting bracket	○	○	○	○	○	○
IntelliSteer® guidance ready	○	○	○	○	○	○
Headland Turn Sequencing (HTS)	○	○	○	○	○	○
Headland Turn Sequencing II (HTS II)	○	○	○	○	○	○
IntelliTurn™ with Headland Turn Sequencing II (HTS II) system	○	○	○	○	○	○
ISOBUS Class II (External and in cab connection)	○	○	○	○	○	○
ISOBUS Class III (External and in cab connection)	○	○	○	○	○	○
<b>Fleet - Offboard Systems</b>						
IntelliField™ boundary, map & guidance line data inter-vehicle sharing	○	○	○	○	○	○
MyPLM™Connect Essential telematics	○	○	○	○	○	○
MyPLM™Connect Professional telematics	○	○	○	○	○	○
<b>Uptime Solutions - Training &amp; Support Systems</b>						
New Holland Breakdown Assist	●	●	●	●	●	●
<b>Weights (Classic armrest models / SideWinder™ II armrest models)</b>						
Minimum shipping weights*****	5430 / 5680	5430 / 5680	5610 / 5860	- / 5740	- / 5740	5610 / 5680
Typical working weight	6110 / 6360	6110 / 6360	6290 / 6540	- / 6420	- / 6420	6290 / 6540
Max. permissible weight	10500 / 10500	10500 / 10500	10500 / 10500	- / 10500	- / 10500	10500 / 10500

● Standard ○ Optional - Not available

\* Developed by FPT Industrial \*\* Biodiesel blend must fully comply with the latest fuel specification EN14214:2009 and operation is in accordance with operator manual guidelines

\*\*\* Linked Class 4 front axle \*\*\*\* Only available with Classic armrest \*\*\*\*\* Weight carrier, standard axle, 18.4R38 tyres



## Dimensions

Dimensions on rear tyres <sup>4</sup>		16.9R38	18.4R38	520/70R38	600/65R38	650/65R38 <sup>9</sup>
<b>A</b> Overall length inc. front linkage to rear linkage	(mm)	5189	5189	5189	5189	5189
<b>B</b> Min. width	(mm)	2280	2280	2280	2280	2314
<b>C1</b> Height at centre of rear axle to top of low profile cab	(mm)	1980	1980	1980	1980	1980
<b>C2</b> Height at centre of rear axle to top of standard cab	(mm)	2100	2100	2100	2100	2100
<b>C2</b> Height at centre of rear axle to top of Comfort Ride™ suspension cab	(mm)	2165	2165	2165	2165	2165
<b>D1</b> Overall height of low profile cab	(mm)	2780	2805	2805	2805	2855
<b>D2</b> Overall height of standard cab	(mm)	2900	2925	2925	2925	2975
<b>D2</b> Overall height of Comfort Ride™ suspension cab	(mm)	2965	2990	2990	2990	3040
<b>Wheelbase</b>						
<b>E</b> Standard 4WD axle	(mm)	2642	2642	2642	2642	2642
<b>E</b> Terraglide™ suspended axle	(mm)	2684	2684	2684	2684	2684
<b>F</b> Track width [min. / max.]	(mm)	1460 / 2134	1530 / 2134	1634 / 2134	1634 / 2134	1664 / 2134
<b>G</b> Ground clearance	(mm)	427	478	478	478	528

<sup>4</sup> Rear tyres other than those mentioned are available: 480/70R38, 540/65R38, 650/60R38 <sup>9</sup> Only compatible with Comfort Ride™ cab suspension

# New Holland Top Service: customer support and customer information.



### Top Availability

If you need information, or have an out of hours question, ring our toll-free number\*. All day, every day, we are just a call away.



### Top Speed

Express parts delivery: when you need it, where you need it!



### Top Priority

Fast-track solution during the season: because your harvest can't wait!



### Top Satisfaction

We drive and track the solution you need, keeping you informed: until you are 100% satisfied!



### For more details, ask your New Holland dealer!

\* Calls to the Top Service team are free from landlines in the United Kingdom and Republic of Ireland. UK-based mobile calls are also free, but Republic of Ireland mobile users should call 01 2421881 and this will be charged at your standard network rate.

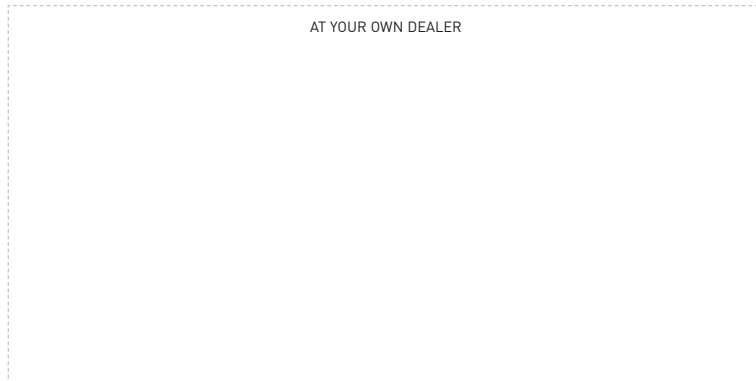

[www.newholland.com/uk](http://www.newholland.com/uk) - [www.newholland.com/ie](http://www.newholland.com/ie)

